



RATINGS

Maximum Flow See Chart
Maximum Operating Pressure
("A", "B" and "P" Ports) 350 bar (5000 PSI)
Maximum Tank Line Pressure 103 bar (1500 PSI)
Mounting Pattern ISO 4401-AB-03-4-A, NFPA-D03
(Formerly D01) and ANSI-B93.7

FLUIDS AND SEALS

Valves using synthetic, fire-resistant fluids require special seals. When phosphate ester or its blends are used, FLUOROCARBON seals are required. Water-glycol, water-in-oil emulsions, and petroleum oil may be used with NITRILE seals.

WEIGHT

Single Solenoid Models 1.36 kg (3.0 lbs.)
Double Solenoid Models 1.6 kg (3.5 lbs.)

FILTRATION

For maximum valve and system component life, the system should be protected at a contamination level not to exceed 125 particles greater than 10 microns per milliliter of fluid (SAE Class 4 or better, ISO Code 16/13).

SILTING

Silting can cause any sliding spool valve to stick and not spring return, if held shifted under pressure for long periods of time. The valve should be cycled periodically to prevent sticking.

MOUNTING BOLTS

When provided by customer, mounting bolts should be SAE Grade 8, 10-24 UNC-2A; or better.
(Bolt Length = 1.25 inches)
Bolt Torque 5.6N (50 in-lbs.)

D03 Solenoid Electrical Characteristics

[Based on nominal voltage @ 22°C (72°F)]

Nominal Volts/Hz	In Rush Amps	Holding Amps	Watts
120/60 VAC 110/50 VAC	2.00 2.10	0.49 0.58	25 27
240/60 VAC 220/50 VAC	1.00 1.05	0.26 0.31	25 27
24/60 VAC	10.50	2.70	27
24/50 VAC	8.7	2.65	28
6VDC	-	5.00	30
12VDC	-	2.50	30
24VDC	-	1.25	30
120VDC	-	0.25	30

TANK LINE SURGES

If several valves are piped with a common tank line, flow surges in the line may cause unexpected spool shift. Detent style valves are most susceptible to this. Separate tank lines should be used when line surges are expected in an application.

SOLENOID ENERGIZING

Spring centered and spring offset types will be spring positioned unless solenoid is energized continuously.

NOTE: Solenoids are designed to function continuously at ± 10% of the rated voltage.



RATINGS

Recommended Flow Capacity See chart.
Maximum Operating Pressure 207 bar (3000 PSI)
Maximum Tank Line Back Pressure
..... 103 bar (1500 PSI)
Mounting Pattern ISO 4401-05/NFPA-D05
(Formerly D02) and ANSI-B93.7

FLUIDS AND SEALS

Valves using synthetic, fire-resistant fluids require special seals. When phosphate ester or its blends are used, FLUOROCARBON seals are required. Water-glycol, water-in-oil emulsions, and petroleum oil may be used with NITRILE seals.

WEIGHT

Single Solenoid Models 5.3 kg (11.6 lbs.)
Double Solenoid Models 7.3 kg (16.0 lbs.)

FILTRATION

For maximum valve and system component life, the system should be protected at a contamination level not to exceed 125 particles greater than 10 microns per milliliter of fluid (SAE Class 4 or better, ISO Code 16/13).

SILTING

Silting can cause any sliding spool valve to stick and not spring return, if held shifted under pressure for long periods of time. The valve should be cycled periodically to prevent sticking.

D05 Solenoid Electrical Characteristics

[Based on nominal voltage @ 22°C (72°F)]

Nominal Volts/Hz	In Rush VA	Holding VA	Nominal Watts (Ref)
120/60 VAC 110/50 VAC	298 294	95 102	32
240/60 VAC 220/50 VAC	288 288	96 101	32
24/60 VAC 24/50 VAC	290 381	77 110	32
12VDC	-	3.00	36
24VDC	-	1.50	36
120DC	-	0.30	36

* DC holding amps

MOUNTING BOLTS

When provided by customer, mounting bolts should be SAE Grade 8, ¼-20 UNC-2A; or better.

Maximum recommended mounting bolt torque
..... 16Nm (12 ft-lbs.)
(Bolt Length = 1.62 inches)

TANK LINE SURGES

If several valves are piped with a common tank line, flow surges in the line may cause unexpected spool shift. Detent style valves are most susceptible to this. Separate tank lines should be used when line surges are expected in an application.

SOLENOID ENERGIZING

Spring centered and spring offset types will be spring positioned unless solenoid is energized continuously.

NOTE: Solenoids are designed to function continuously at ± 10% of the rated voltage.

OPERATING AND TECHNICAL DATA

D03 Pressure Drop Reference Chart

Spool Center Position	Curve Number							Maximum Flow, L/M (GPM) 350 Bar (5000 PSI) w/o Malfunction
	P-A	P-B	P-T	A-T	B-T	B-A	A-B	
	4	4	-	1	1	-	-	49 (13)
	3	3	4	1	1	4	4	45(12)
	4	4	-	1	1	-	-	30 (8)
	2	2	5	4	4	5	5	45 (12)

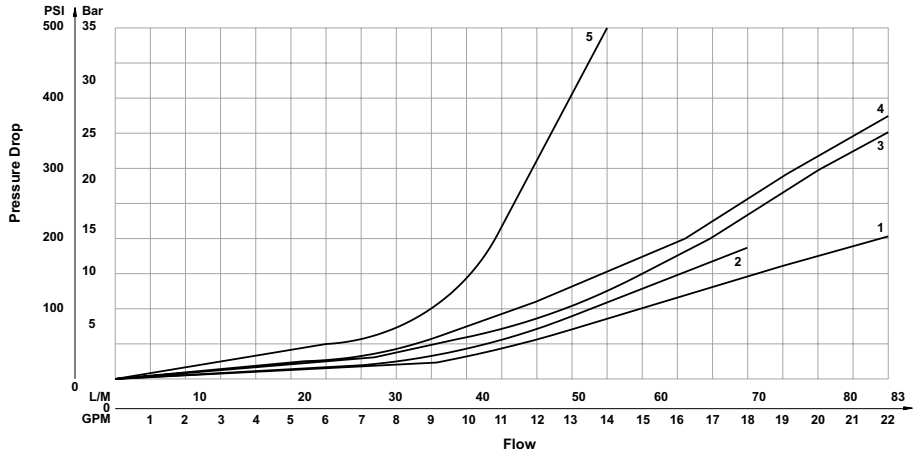

OPERATING AND TECHNICAL DATA

D05 Pressure Drop Reference Chart

Spool Center Position	Curve Number										Maximum Flow, L/M (GPM) 350 Bar (5000 PSI) w/o Malfunction	
	Shifted				Center Condition							
	P-A	P-B	B-T	A-T	(P-T)	(B-A)	(A-B)	(P-A)	(P-B)	(A-T)		(B-T)
	5	5	2	2	-	-	-	-	-	-	-	130 (33)
	4	4	1	1	2	3	3	3	3	1	1	115 (30)
	4	4	3	3	-	-	-	-	-	1	1	130 (33)
	8	8	7	7	6	-	-	-	-	-	-	39 (10)

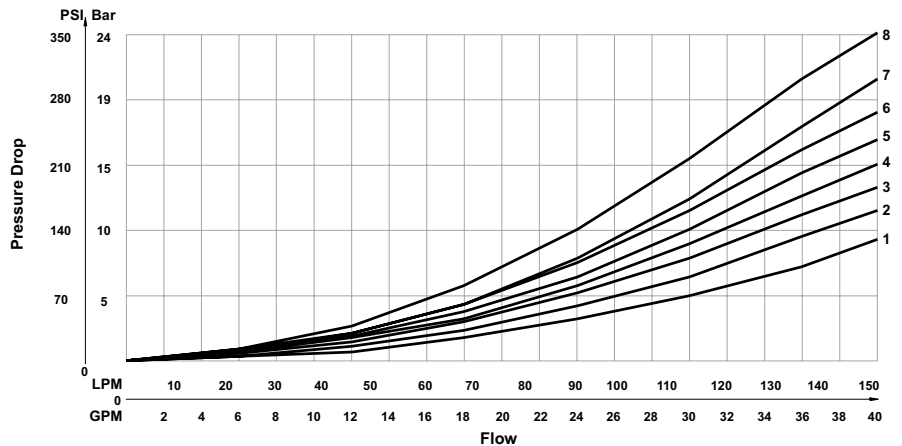

UNIT DIMENSIONS

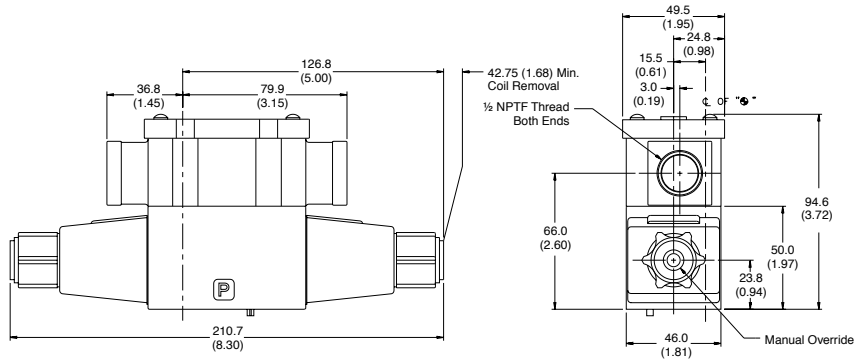

Double Solenoid

NOTE:

Mounting bolt spacing helps to insure proper mounting and port relationship.

Spring centered models - when solenoid is deenergized the spool is returned to the spring centered position.

DIMENSIONS SHOWN FOR AC COILS
MILLIMETERS (INCHES)

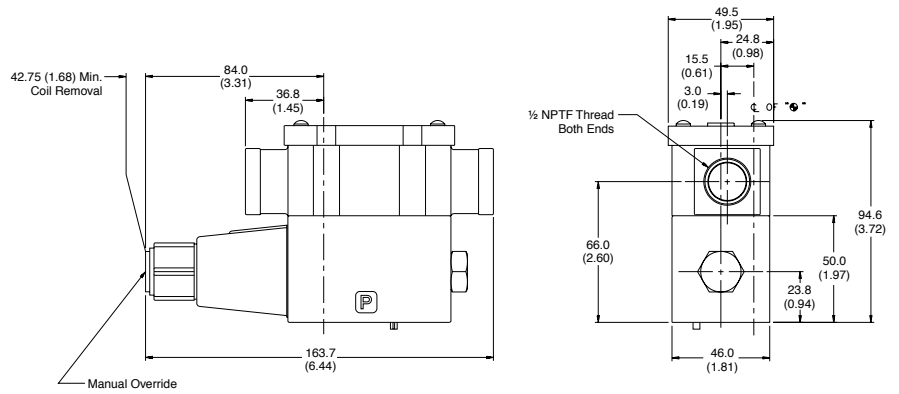

Single Solenoid Spring Offset

UNIT DIMENSIONS

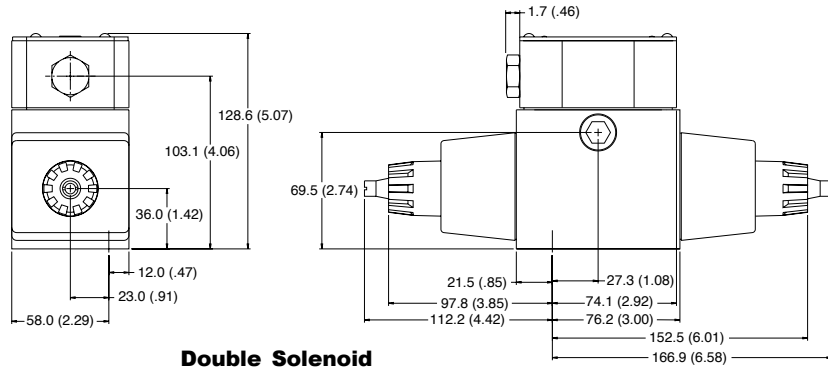

Double Solenoid

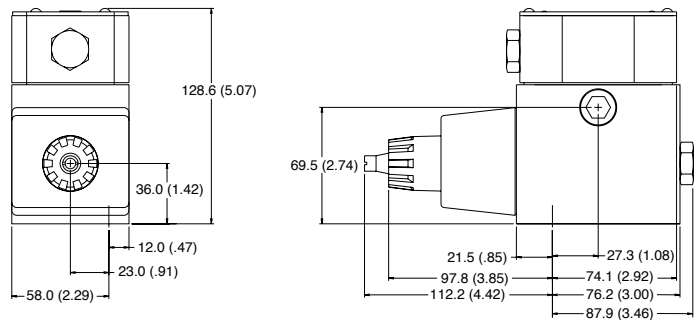

Single Solenoid Spring Offset

DIMENSIONS SHOWN FOR AC COILS
MILLIMETERS (INCHES)



PRODUCT SELECTION DATA

GENERAL DATA

Models are direct solenoid operated four-way directional control valves. Their primary function, in a hydraulic circuit, is to determine the direction of fluid flow to a work cylinder, or control the direction of rotation of a fluid motor. Port connections are made by mounting the valve on a subplate or manifold. The valve has wet armature type solenoids.

Electrical connections to the valve are made in the electrical wiring housing or by various plug-in devices. A ground terminal is provided.

DIRECTIONAL CONTROL VALVES

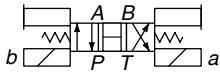

SCHEMATIC "A"

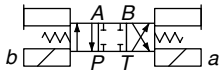

SCHEMATIC "B"



SCHEMATIC "C"

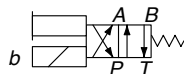

SCHEMATIC "D"

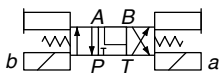

SCHEMATIC "E"

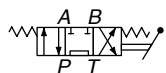

SCHEMATIC "F"

NFPA • D03 ISO-4401-03

Part No.	Description	Voltage	Schematic
00961-P	Valve, 4-Way/3 Position, Closed Center, Double Solenoid	12 VDC	"B"
00962-P	Valve, 4-Way/3 Position, Tandem Center, Double Solenoid	12 VDC	"C"
00963-P	Valve, 4-Way/3 Position, Open Center, Double Solenoid	12 VDC	"A"
00964-P	Valve, 4-Way/3 Position, Closed Center, Double Solenoid	24 VDC	"B"
00965-P	Valve, 4-Way/3 Position, Tandem Center, Double Solenoid	24 VDC	"C"
00966-P	Valve, 4-Way/3 Position, Open Center, Double Solenoid	24 VDC	"A"
00968-P	Valve, 4-Way/3 Position, Closed Center, Double Solenoid	110 VAC	"B"
00970-P	Valve, 4-Way/3 Position, Tandem Center, Double Solenoid	110 VAC	"C"
00967-P	Valve, 4-Way/3 Position, Open Center, Double Solenoid	110 VAC	"A"
01039-P	Valve, 4-Way/3 Position, P Closed, A & B to T, Double Solenoid	24 VDC	"E"
01040-P	Valve, 4-Way/3 Position, P Closed, A & B to T, Double Solenoid	12 VDC	"E"
01041-P	Valve, 4-Way/2 Position, Spring Offset, B Solenoid	110 VAC	"D"
00969-P	Valve, 4-Way/3 Position, P Closed, A & B to T, Double Solenoid	110 VAC	"E"
00957-P	Valve, 4-Way/3 Position, Tandem Center, Manual	-----	"F"
00460-P	Valve, 4-Way/2 Position, Spring Offset, B Solenoid	12 VDC	"D"
00461-P	Valve, 4-Way/2 Position, Spring Offset, B Solenoid	24 VDC	"D"

NFPA • D05 ISO-4401-05

Part No.	Description	Voltage	Schematic
01060-P	Valve, 4-Way/3 Position, Tandem Center, Double Solenoid	110 VAC	"C"
01061-P	Valve, 4-Way/3 Position, Open Center, Double Solenoid	110 VAC	"A"
01062-P	Valve, 4-Way/3 Position, Closed Center, Double Solenoid	110 VAC	"B"
01063-P	Valve, 4-Way/3 Position, P Closed, A & B to T, Double Solenoid	110 VAC	"E"
01064-P	Valve, 4-Way/2 Position, Spring Offset, B Solenoid	110 VAC	"D"
00462-P	Valve, 4-Way/3 Position, Tandem Center, Double Solenoid	12 VDC	"C"
00463-P	Valve, 4-Way/3 Position, Open Center, Double Solenoid	12 VDC	"A"
00464-P	Valve, 4-Way/3 Position, Closed Center, Double Solenoid	12 VDC	"B"
00465-P	Valve, 4-Way/3 Position, P Closed, A & B to T, Double Solenoid	12 VDC	"E"
00475-P	Valve, 4-Way/2 Position, Spring Offset, B Solenoid	12 VDC	"D"
00476-P	Valve, 4-Way/3 Position, Tandem Center, Double Solenoid	24 VDC	"C"
00477-P	Valve, 4-Way/3 Position, Open Center, Double Solenoid	24 VDC	"A"
00478-P	Valve, 4-Way/3 Position, Closed Center, Double Solenoid	24 VDC	"B"
00479-P	Valve, 4-Way/3 Position, P Closed, A & B to T, Double Solenoid	24 VDC	"E"
00480-P	Valve, 4-Way/2 Position, Spring Offset, B Solenoid	24 VDC	"D"

NFPA • D03 & NFPA • D05

D03	D05	Description	Schematic
00466-P	00766-P	P Port Direct Check D03 5 PSI, D05 15 PSI	"G"
00467-P	00767-P	P Port Direct Check D03 50 PSI, D05 73 PSI	"G"
00468-P	00768-P	Dual Pilot Operated Check D03 & D05 15 PSI	"H"
00469-P	00769-P	Dual Meter-Out Flow Control	"I"
00470-P	00770-P	P → T Single Relief D03 75-3600 PSI, D05 60-2900 PSI	"J"
00471-P	00771-P	P Port Pressure Reducing D03 1450-3600 PSI, D05 125-2900 PSI	"K"
00472-P	00772-P	P Port Sequence Valve D03 725-2000 PSI, D05 73-2900 PSI	"L"
00474-P	00773-P	Dual Relief A & B → T D03 250-3500 PSI, D05 60-2900 PSI	"M"
00443-P	00765-P	Crossline Relief D03 725-3600 PSI, D05 60-2900 PSI	"N"
00481-P	00763-P	Blanking Plate	"N/A"
00442-P	00774-P	Single Relief A → T D03 100-2000 PSI, D05 60-2900 PSI	"O"

NOTE: For information on additional valves and pressure ranges consult factory.



SCHEMATIC "G"

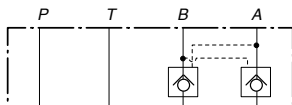

SCHEMATIC "H"

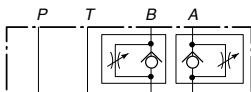

SCHEMATIC "I"

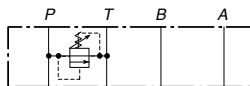

SCHEMATIC "J"

AUXILIARY VALVE MODULES

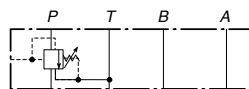

SCHEMATIC "K"

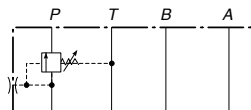

SCHEMATIC "L"

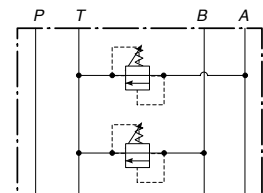

SCHEMATIC "M"

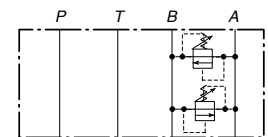

SCHEMATIC "N"

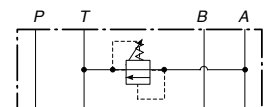

SCHEMATIC "O"

DISTRIBUTED BY:

U.S.A.:
MONARCH HYDRAULICS, INC.
 T UNITS and DISTRIBUTION
 4770 50th St. Kentwood, MI 49512
 Telephone: (616) 458-1306
 Telefax: (616) 455-0240
 http://www.monarchhyd.com

CANADA:
FLUID-PACK INTERNATIONAL LIMITED
 A Part of the Monarch Hydraulics Group
 460 Newbold St., London, Ontario, Canada N6E 1K3
 Telephone: (519) 686-5900
 Telefax: (519) 686-8976

Catalog information also available at :

www.monarchhyd.com